



Description

The JOR217 Photo relay consist of a photo MOSFET、Photovoltage generator、infrared LED.



Features

- Normally opened (SPST)
- Control 200V AC or DC voltage
- Switch 180mA load
- Controls low-level analog signal
- High sensitivity, low conductivity resistance
- Low-level off state leakage current
- High isolation voltage 3750V_{rms}
- Lead free, meet RoHS standards

Applications

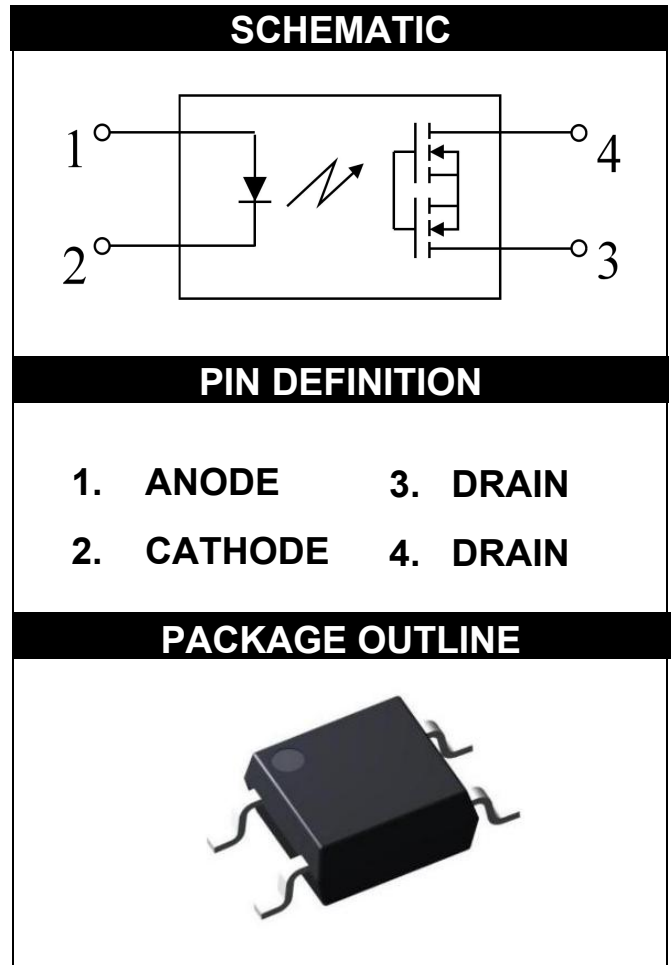
- Communications products (Personal computers, Laptops)
- Modem/Sensor
- Mobile phones/Security equipment
- Measuring and Testing equipment
- Plant automation equipment
- High-speed inspection machines

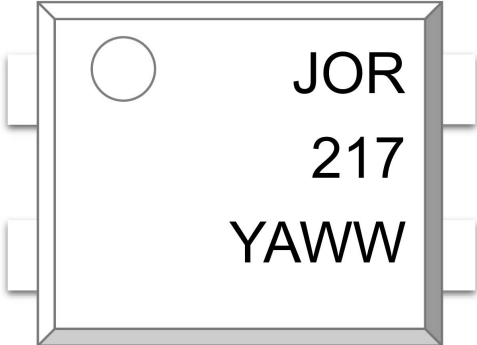

ORDERING AND MARKING INFORMATION	
MARKING INFORMATION	
	<p>JOR : Company Abbr. 217 : Part Number Y : Fiscal Year A : Manufacturing Code WW : Work Week</p>
ORDERING INFORMATION	LABEL INFORMATION
<p style="text-align: center;">JOR217(Z)-GV</p> <p>JOR– Company Abbr 217 – Part Number Z – Tape and Reel Option (T1/T2) G – Green V – VDE</p>	

Insulation and Safety related specifications

Item	Symbol	Value	Unit	Note
Creepage Distance	L	5.0	mm	Measured from input terminals to output terminals, shortest distance path along body.
Clearance Distance	L	5.0	mm	Measured from input terminals to output terminals, shortest distance through air.
Insulation Thickness	DTI	0.3	mm	Insulation thickness between emitter and detector.
Peak Isolation Voltage	V_{IORM}	600	V_{peak}	DIN/EN/IEC EN60747-5-5.
Transient Isolation Voltage	V_{IOTM}	5000	V_{peak}	DIN/EN/IEC EN60747-5-5.
Isolation Voltage	V_{ISO}	3750	V_{rms}	For 1 minute.

Absolute Maximum Ratings ($T_A=25^{\circ}C$)

Parameter		Symbol	Rating	Unit
Input	LED Forward Current	I_F	50	mA
	LED Reverse Voltage	V_R	5	V
	Peak Forward Current	I_{FP}	1	A
	Power Dissipation	P_{in}	75	mW
Output	Load Voltage (Peak AC)	V_L	200	V
	Continuous Load Current	I_L	0.18	A
	Peak Load Current	I_{peak}	0.54	A
	Power Dissipation	P_{out}	300	mW
Isolation Voltage		V_{ISO}	3750	V_{rms}
Operating Temperature		T_{opr}	-40~+85	$^{\circ}C$
Storage Temperature		T_{stg}	-40~+100	$^{\circ}C$
Soldering Temperature		T_{sol}	260	$^{\circ}C$

Electro-optical Characteristics (T_A=25°C)

Parameter		Symbol	Condition	Min.	Typ.	Max.	Unit
Input	LED Operate Current	I _{Fon}	I _L = 0.18A	-	0.6	3	mA
	LED Turn Off Current	I _{Foff}	I _L = 0.18A	0.05	0.5	-	mA
	LED Dropout Voltage	V _F	I _F =5mA	1	1.3	1.4	V
Output	On Resistance	R _{on}	I _F = 5mA , I _L = 0.18A Within 1s on time	-	2.2	5	Ω
	Off State Leakage Current	I _{Leak}	I _F = 0mA V _L = 200V	-	-	1000	nA
Transfer Characteristics	Turn On Time	T _{on}	I _F = 5mA I _L = 0.18A R _L =200Ω	-	0.16	2	ms
	Turn Off Time	T _{off}	I _F = 5mA I _L = 0.18A R _L =200Ω	-	0.14	1	ms
	I/O Capacitance	C _{ISO}	f = 1 MHz V _B = 0V	-	0.8	1.5	pF
	Initial I/O Isolation Resistance	R _{ISO}	500 V DC	1000	-	-	MΩ

Typical Electro-Optical Characteristics Curves

Fig.1 LED Dropout Voltage vs. Ambient Temperature

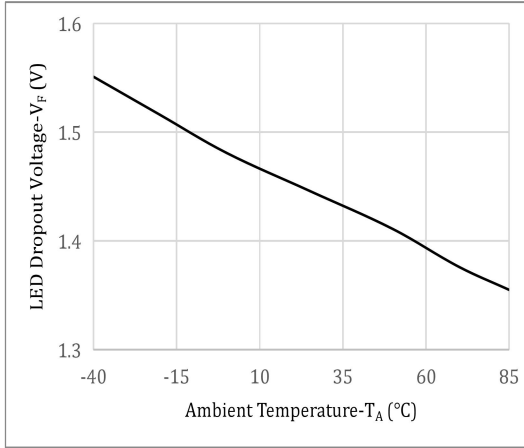

Fig.2 Output Current vs. Output Voltage

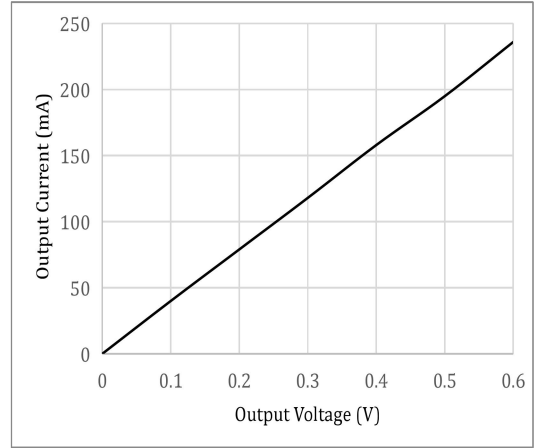

Fig.3 On Resistance vs. Ambient Temperature

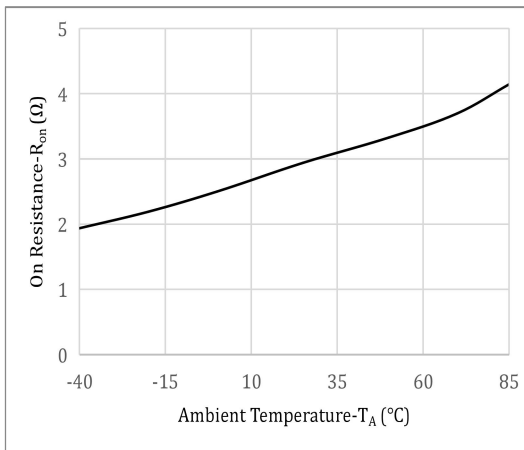

Fig.4 Load Current vs. Ambient Temperature

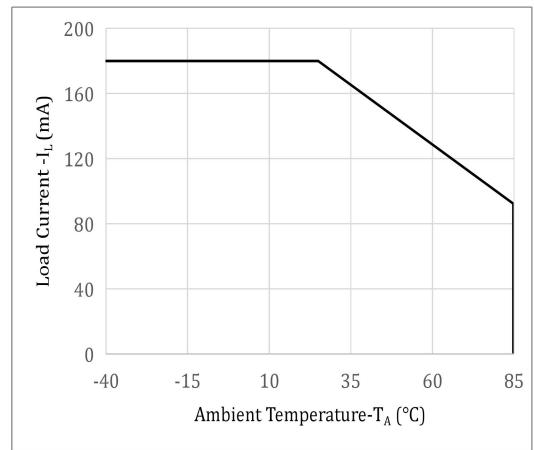

Fig.5 LED Operate Current vs. Ambient Temperature

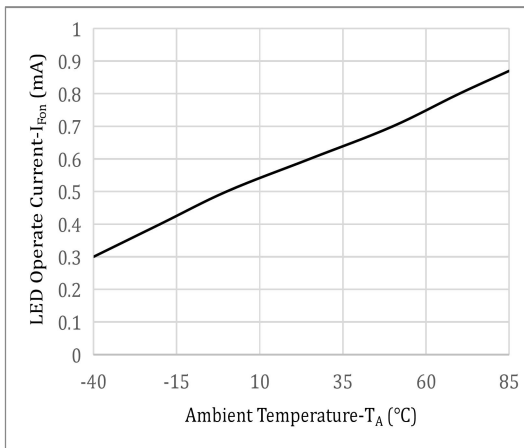

Fig.6 LED Turn Off Current vs. Ambient Temperature

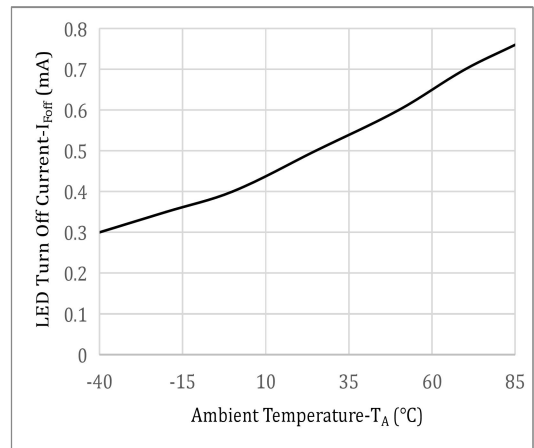

Fig.7 Turn On Time vs. Ambient Temperature

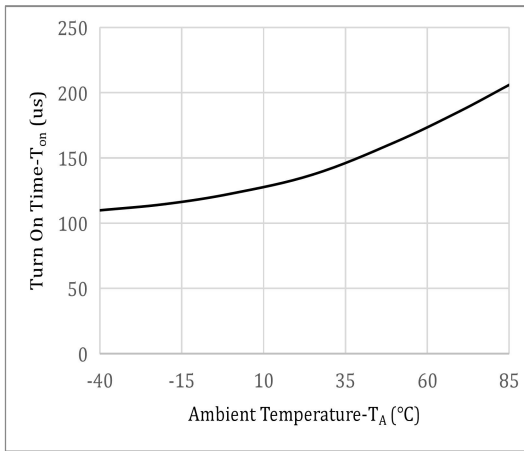

Fig.8 Turn Off Time vs. Ambient Temperature

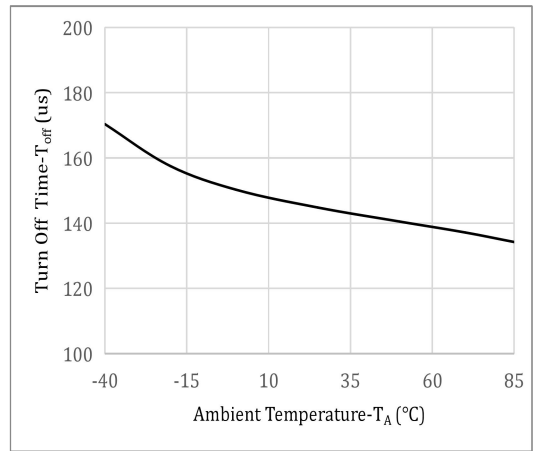

Fig.9 Turn On Time vs. LED Forward Current

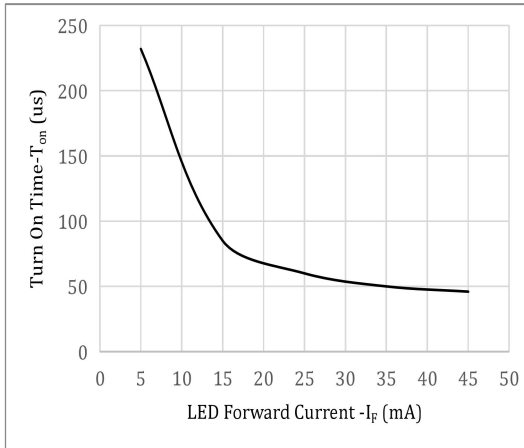
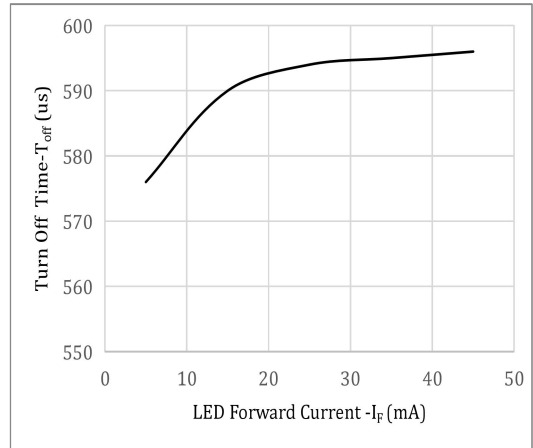
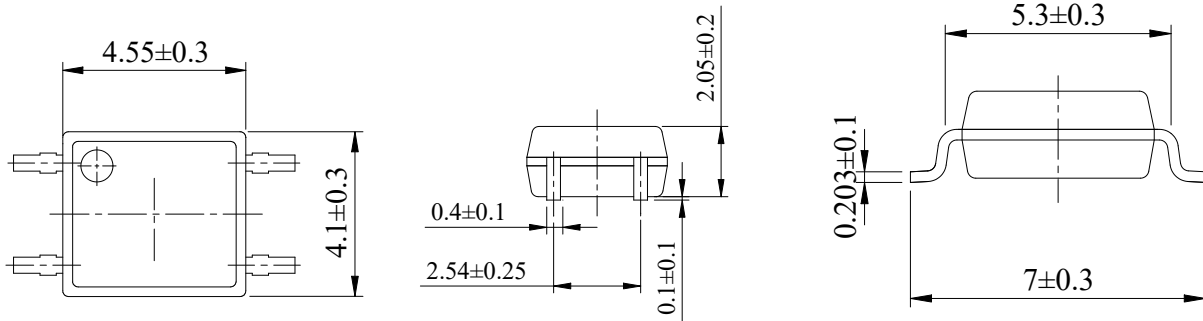

Fig.10 Turn Off Time vs. LED Forward Current



Outline Dimensions

SOP4



Unit: mm

Recommended Pad Layout

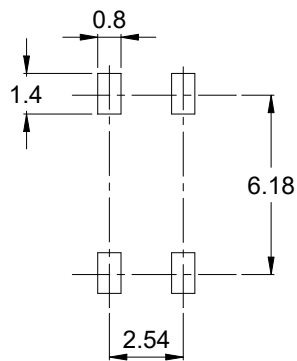

Unit: mm

Note > The picture above is the front view of the product.

Solder Reflow Profile

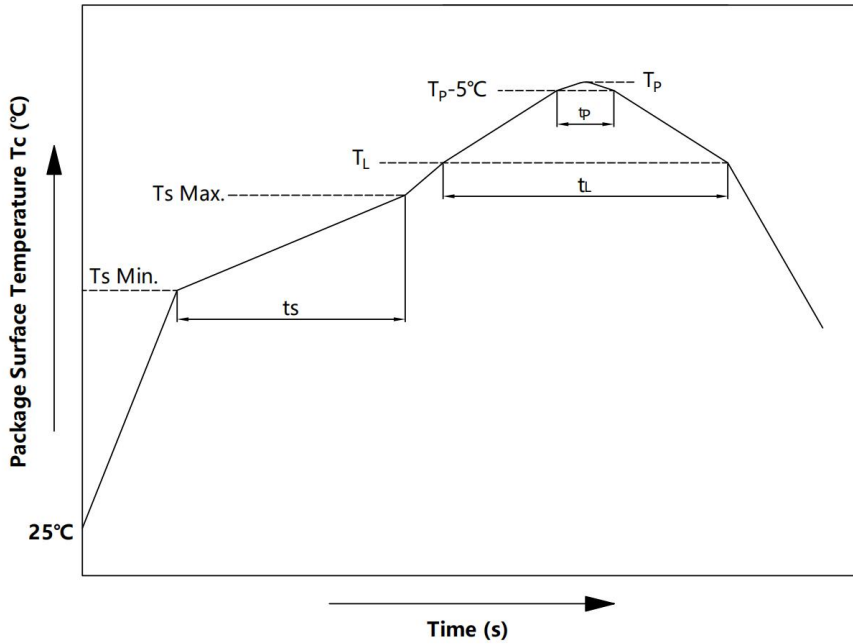

Item	Symbol	Min.	Max.	Unit
Preheat Temperature	T_s	150	200	$^\circ\text{C}$
Preheat Time	t_s	60	120	s
Ramp-Up Rate (T_L to T_p)	-	-	3	$^\circ\text{C}/\text{s}$
Liquidus Temperature	T_L	217		$^\circ\text{C}$
Time Above T_L	t_L	60	150	s
Peak Temperature	T_p	-	260	$^\circ\text{C}$
Time During Which T_c Is Between (T_p-5) and T_p	t_p	-	30	s
Ramp-down Rate(T_p to T_L)	-	-	6	$^\circ\text{C}/\text{s}$

Note: Reflow soldering is recommended at the temperatures and times shown, no more than three times.

Wave Soldering Profile

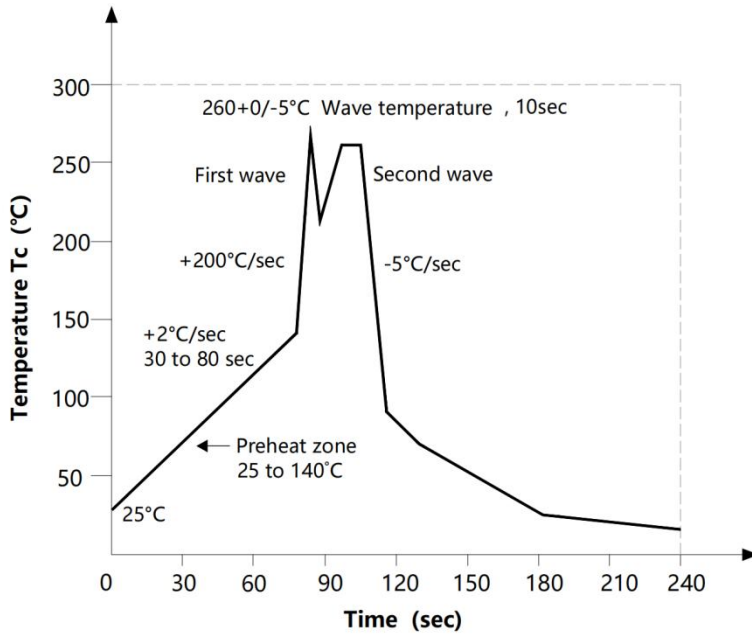

Soldering with hand soldering iron

- A. Hand soldering iron is only used for product rework or sample testing;
- B. Manual soldering method Temperature: 360°C ± 5°C, within 3s.

Packing

Summary table

Package Type	Packing Form	Quantity per Reel	Quantity per Box	Quantity per Carton	Antistatic Bag Specification	Box Specification	Carton Specification	Note
SOP4	Reel (φ330mm Blue)	3000 pcs /reel	2 reels /box	10 boxes /ctn	380*380mm	340*60*340 mm	620*360*365cm	Leave at least 200mm of blank space at both ends

Tape & Reel

- 1) Qty/reel: 3000 pcs.
- 2) Qty/ctn: 60000 pcs.
- 3) Inner packing: 2 reels/box.
- 4) Schematic:

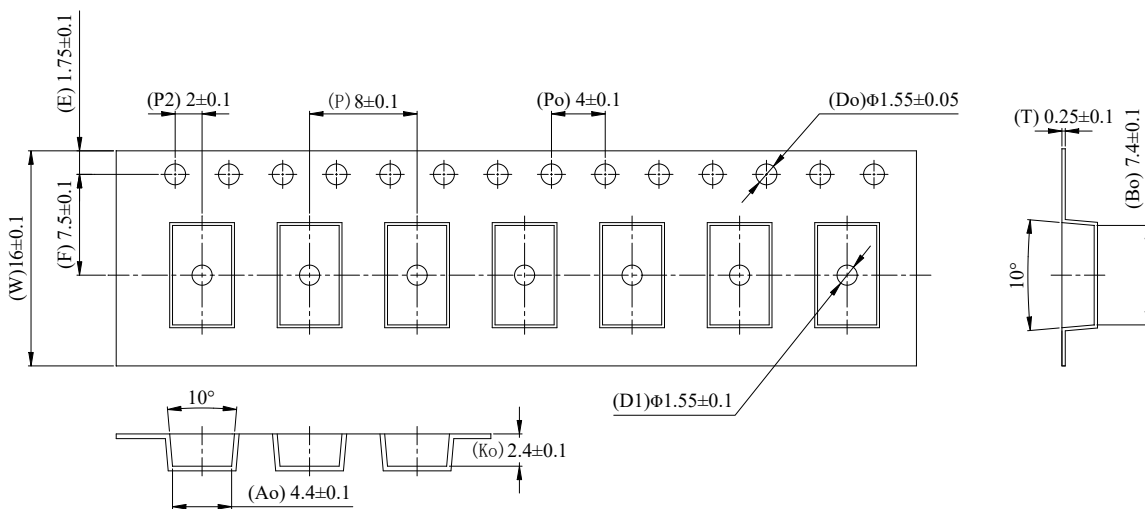

Unit: mm